

PiezoDrive

PDu100

Miniature 200 Vp-p Piezo Driver with
Built-in High-Voltage Power Supply
Size: 12x10 mm, Weight: 0.5 gram



The PDu100 is the industry's smallest and lightest driver for piezoelectric actuators. The PDu100 can drive two-wire piezoelectric actuators and benders up to ± 100 V. The PDu100 can also drive three-wire piezoelectric benders and stack actuators up to +100 V. Applications include battery powered robotics, piezoelectric motors, and ultra low-power positioning and manipulation systems.

The PDu100 is protected against short circuit, current overload, and excessive temperature. A shutdown pin is also provided that reduces the supply current to 1 mA when pulled low.

The output voltage range and gain of the PDu100 is customizable to meet the requirements of OEM applications.

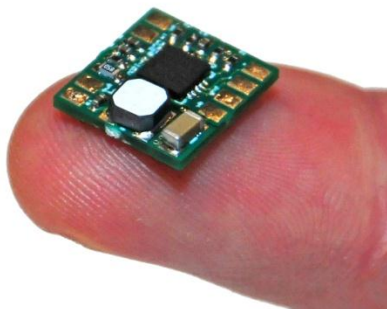

Specifications	
Power Supply	3 V to 5.5 V
Max Unipolar Output	+100 V
Max Bipolar Output	± 100 V
Av. Output Current	± 15 mA
Power Bandwidth	3.2 kHz
Peak Output Current	100 mA
Signal Bandwidth	60 kHz (unloaded)
Dimensions	11.8 x 12.9 mm (0.46 x 0.51 in)
Weight	560 mg (0.018 oz)
Gain	27.5 V
Input Voltage	$V_s/2 \pm 1.8$ V ($Z_{in} = 100k$)
Input Offset	± 100 mV
Load	Unlimited capacitive loads
Overload	Thermal and current overload protection
Noise	70mV RMS (270 Ω + 10uF Load)
Environment	-40 to 70°C (-40 to 158°F) Non-condensing humidity
Quiescent Current	25 mA (1 mA in Shutdown)

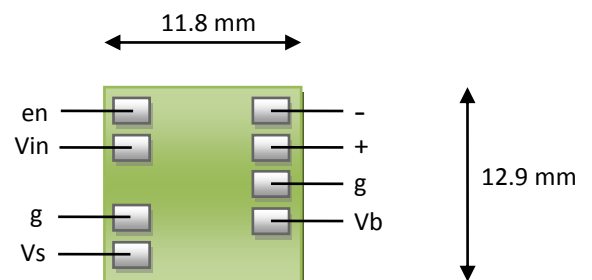

Inputs		Outputs	
en	Enable	-	Negative Out
Vin	Input	+	Positive Out
G	Ground	g	Ground
Vs	Supply Voltage	Vb	Bias Voltage

Figure 1. Connection diagram

Operation

The system block diagram is illustrated in Figure 2. A boost converter generates a high-voltage rail to supply a pair of complementary amplifiers. A single output can be used to drive a unipolar load up to +100 V or both amplifiers can be used to produce ± 100 V.

The input is selectable between a unipolar signal biased at half the supply voltage or a bipolar signal. The amplifier gain is 27.5 so a 3.6 V_{p-p} input will produce a 100 V_{p-p} output. Both amplifier channels are biased at half the output range (50 V).

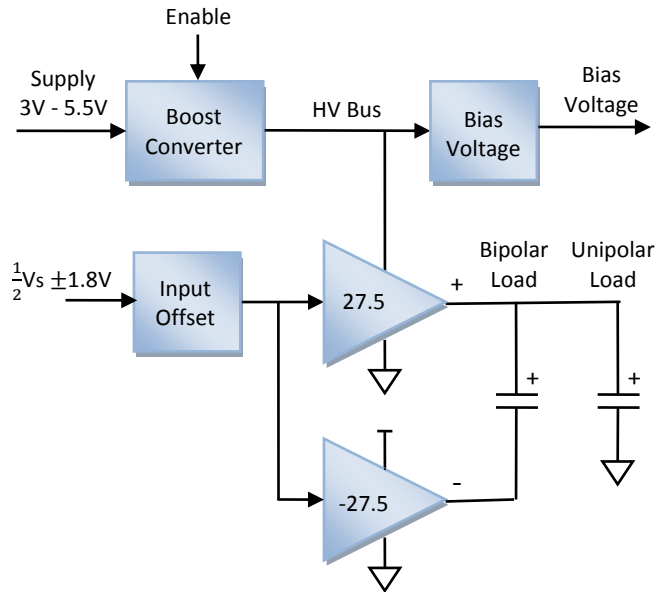

Figure 2. PDu100B Block Diagram

The overall system gain is determined by the output configuration. The possible combinations are listed below.

Output Type	Gain	Input Range	Output Range
Unipolar	27.5	$\frac{1}{2} V_s \pm 1.8$ V	100 V
Bipolar	55	$\frac{1}{2} V_s \pm 1.8$ V	± 100 V

Table 1. System gain and voltage range

Both output amplifiers are biased at approximately half the HV Bus voltage, i.e. 50 V.

The gain and output voltage ranges can be customized by contacting info@piezodrive.com.

Output Current

The maximum average output current is ± 15 mA. However, for periods less than 100 μ s an output current of approximately 100 mA is possible. This is useful for achieving small, high-speed step changes in the output voltage.

Example Applications

Some typical application circuits are shown below. The optional output resistance R_o is used to reduce noise as described in “Noise” on page 3

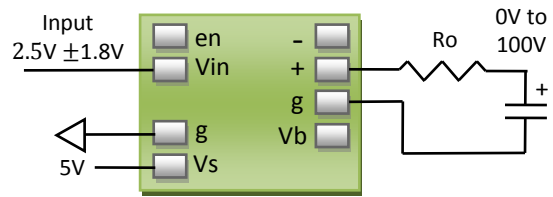

100 V Piezo stack driver with 50 V bias

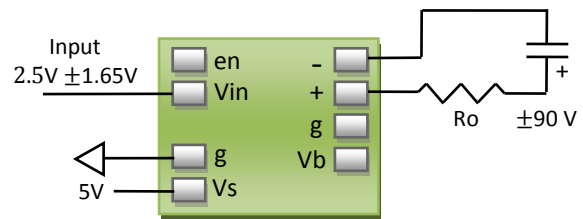

± 90 V Piezo bender driver

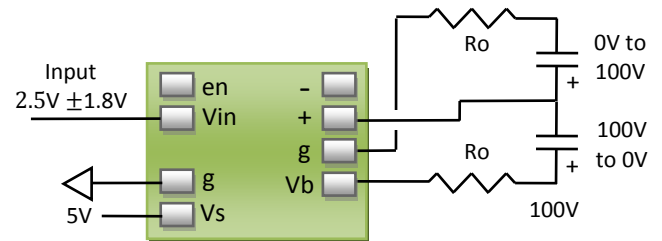

100 V Three-wire bender driver with bias

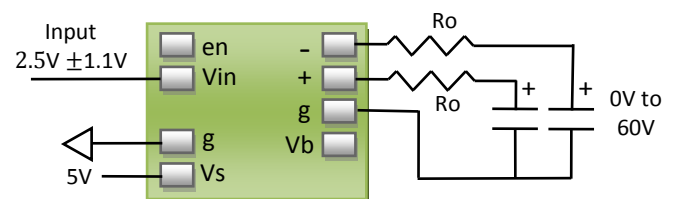

60 V Push-pull stack driver or bender driver

Figure 3. Application circuits

Power Bandwidth

The output slew-rate of the PDu100 is 1 V/ μ s. Therefore, the maximum frequency sine-wave is

$$f_{max} = \frac{1 \times 10^6}{\pi V_{L(p-p)}}$$

The power bandwidth for a range of output voltages is listed below

Voltage Range	Power Bandwidth
60 V	5.3 kHz
70 V	4.5 kHz
90 V	3.5 kHz
100 V	3.2 kHz

Table 2. Unloaded power bandwidth

With a capacitive load, the power bandwidth is limited by the maximum output current. For a sine wave

$$f_{pwr} = \frac{I_{av}}{V_{L(p-p)}\pi C_L}$$

The power bandwidth is listed below for a range of load capacitances and output voltages.

Load (uF)	60 V	100 V	±100 V
0.01	5300	3200	2300
0.03	2600	1500	790
0.1	790	470	230
0.3	260	150	79
1	79	47	23
3	26	15	8.0
10	8.0	4.8	2.4
30	2.7	1.6	0.8

Table 3. Power bandwidth versus voltage range

In the following figure, the maximum peak-to-peak voltage is plotted against frequency for a range of capacitive loads.

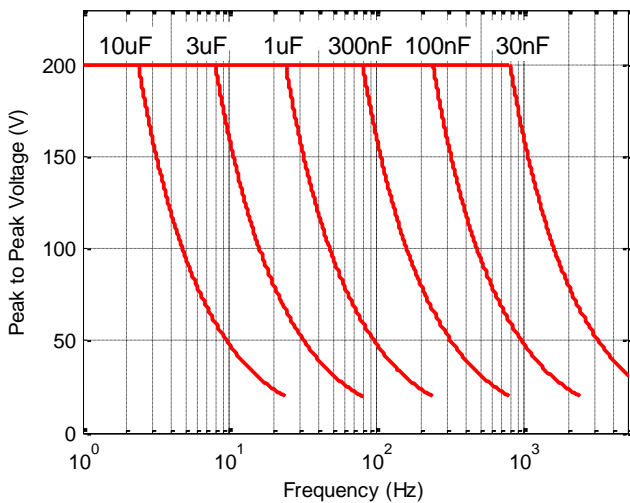

Figure 4. Power bandwidth

Noise

The output voltage of the PDU100 contains switching noise from the boost converter and random noise from the high-voltage amplifier. The amount of noise seen by the load capacitance is determined by the size of the output resistance and signal bandwidth.

To determine the output resistance required for a particular noise level, the required bandwidth should be selected from Figure 5 below. The correct resistance can then be calculated from

$$R_O = \frac{1}{2\pi f_{bw} C_L}$$

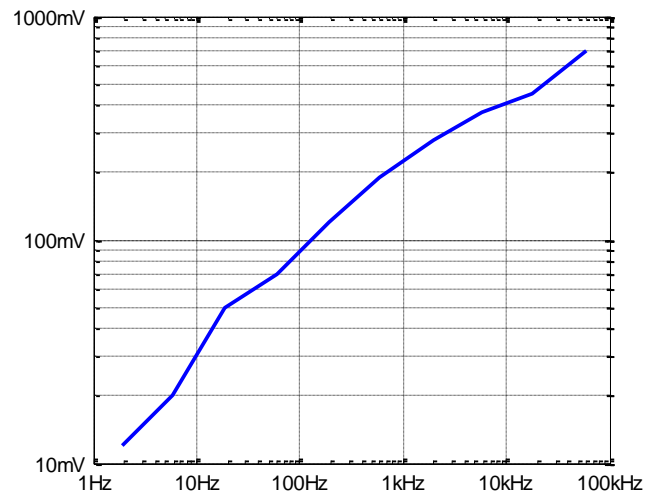

Figure 5. RMS output noise versus bandwidth

The correct circuit configurations for different applications are illustrated in Figure 3.

The noise was measured with a 5 V supply and static input voltage. When current is drawn from the output, the ripple will increase due to action from the boost converter.

Signal Bandwidth

The unloaded small signal bandwidth of the PDU100 is approximately 60 kHz. With a capacitive load, the signal bandwidth is determined by the output resistance, that is

$$f_{bw} = \frac{1}{2\pi R_O C_L}$$

Supply Current

The supply current (I_S) is related to the load current (I_L) through the following power balance equation:

$$I_S = I_L \frac{105}{V_S \times 0.7}$$

where V_S is the supply voltage. With a capacitive load and sinusoidal voltage, the peak and average output current is

$$I_{L(pk)} = \pi f C_L V_{L(p-p)}$$

$$I_{L(av)} = 2f C_L V_{L(p-p)}$$

where, V_L is the peak to peak voltage across the load capacitance. The average supply current can be written

$$I_{S(av)} = 2f C_L V_{L(p-p)} \frac{105}{V_S \times 0.7}$$

Power Dissipation

With a capacitive load, power dissipation is the product of supply voltage and the average current, that is

$$P_D = V_S \times I_{S(av)}$$

When operating at full power bandwidth, the worst-case power dissipation is approximately 2.5 W. The thermal impedance of the PDU100 from junction to ambient is 45 °C/W. Therefore, the maximum temperature rise is approximately 90 °C above ambient.

When continuous power dissipation above 1 W is required, the PDU100 is designed to be mounted onto a thermal sink using a thermally conductive double-sided adhesive such as 3M 8940 or Bergquist BOND-PLY 100.

Enable / Shutdown

The Enable pad can be pulled low to disable the amplifier and reduce the quiescent current to 1 mA. It can be driven by a logic output or an open collector output. The recovery time after a shut-down is 2 ms.

Overload Protection

The PDU100 is protected against over-current and thermal overload. If the temperature exceeds 150 °C the amplifier will be disabled until the temperature reduces.

Dimensions

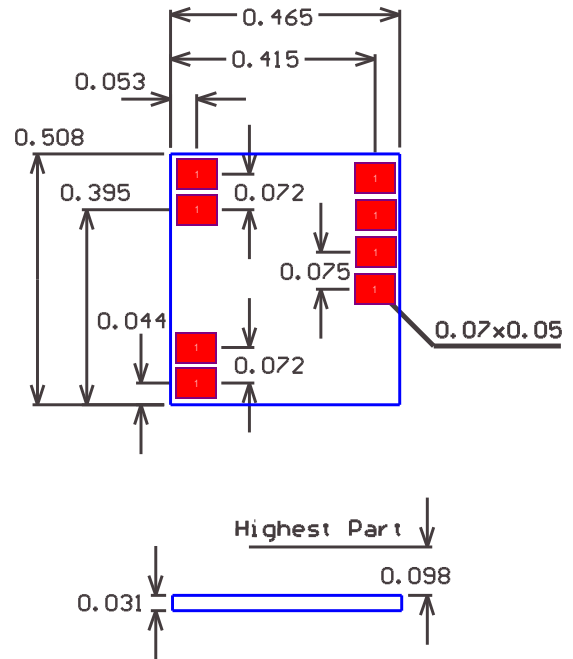

Figure 6. Dimensions (Inches)

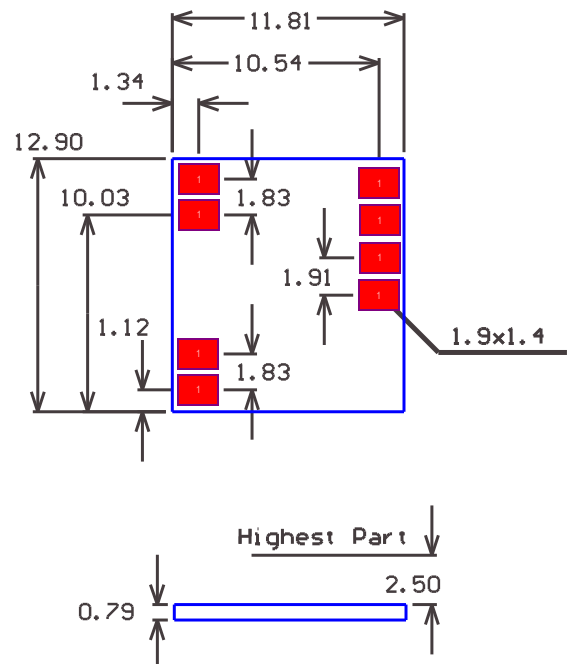

Figure 7. Dimensions (mm)

Contact and Support

info@piezodrive.com