

PiezoDrive

PDu100B

Miniature 200 Vp-p Piezo Driver with
Built-in High-Voltage Power Supply
Size: 39x25 mm, Weight: 3 gram

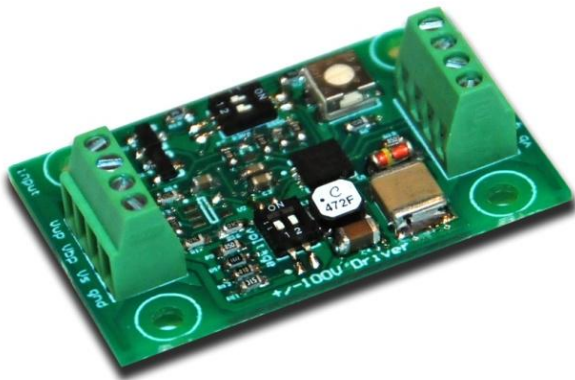

The PDu100B is a complete miniaturized power supply and linear amplifier for driving piezoelectric actuators. The PDu100B provides variable gain and offset, switchable voltage ranges, and the choice between unipolar and bipolar inputs and outputs. The PDu100B can drive two-wire piezoelectric actuators and benders up to ± 100 V and three-wire piezoelectric benders and stack actuators up to +100 V. Applications include piezoelectric valves, motors, pumps, MEMs, and ultra low-power positioning and manipulation systems.

The PDu100B is protected against current overload and excessive temperature. A shutdown pin is also provided that reduces supply current to 1 mA when pulled low.

The PDu100B can be used as a stand-alone module or mounted to a base with four M2.5 threaded spacers. The PCB mounting version (PDu100B-PCB) is supplied with headers for direct mounting on a host motherboard. The PDu100B can also be supplied with no connectors and a heat sink kit for applications that require high power dissipation at elevated temperatures (PDu100B-HS).

Specifications			
Power Supply	3 V to 5.5 V		
Max Unipolar Output	+60 V	+90 V	+100 V
Max Bipolar Output	± 60 V	± 90 V	± 100 V
Av. Output Current	± 40 mA	± 18 mA	± 15 mA
Power Bandwidth	5.3 kHz	3.5 kHz	3.2 kHz
Peak Output Current	100 mA		
Signal Bandwidth	60 kHz (unloaded)		
Dimensions	39 x 25 mm (1.5 x 1 in)		
Weight	5.5 g (0.2 oz)		
Gain	27.5 V		
Input	Unipolar	Bipolar	
Input Impedance	100 k Ω	20 k Ω	
Input Offset	± 100 mV		
Load	Unlimited capacitive loads		
Overload	Thermal and current overload protection		
Noise	70mV RMS (10uF Load)		
Environment	-40 to 70°C (-40 to 158°F) Non-condensing humidity		
Quiescent Current	25 mA (1 mA in Shutdown)		

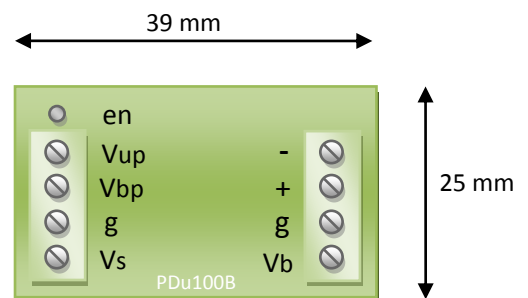

Inputs		Outputs	
en	Enable	-	Negative Out
Vup	Unipolar Input	+	Positive Out
Vbp	Bipolar Input	g	Ground
g	Ground	Vb	Bias Voltage
Vs	Supply Voltage		

Figure 1. Connection diagram

Operation

The system block diagram is illustrated in Figure 2. A boost converter generates a high-voltage rail to supply a pair of complementary amplifiers. A single output can be used to drive a unipolar load up to +100 V or both amplifiers can be used to produce ± 100 V.

The input is selectable between a unipolar signal biased at half the supply voltage or a bipolar signal. The amplifier gain is 27.5 so a 3.6 Vp-p input will produce a 100 Vp-p output. Both amplifier channels are biased at half the output range, e.g. 50 V for the 100 V range.

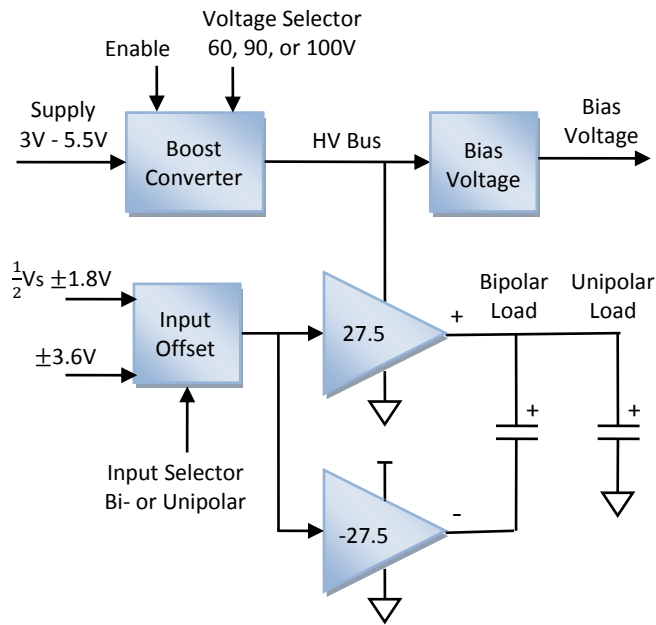

Figure 2. PDu100B Block Diagram

Configuration

The PDu100B can be configured to suit a wide variety of applications. The output voltage range is selected by Switch 1 (S1) as shown below.

S1.1	S1.2	Unipolar Range	Bipolar Range
On	On	100 V	± 100 V
On	Off	90 V	± 90 V
Off	On	70 V	± 70 V
Off	Off	60 V	± 60 V

Table 1. Output voltage range configuration

The input type can be configured to either unipolar or bipolar with Switch 2 (S2), as shown below.

Input Type	S2.1	S2.2	Apply to	Input Range
Unipolar	On	Off	Vup	$\frac{1}{2} V_s \pm 1.8$ V
Bipolar	Off	On	Vbp	± 3.6 V

Table 2. Input type configuration

The overall system gain is determined by the configuration of the input and output. The possible combinations are listed below.

Input Type	Output Type	Gain	Input Range	Output Range
Unipolar	Unipolar	27.5	$\frac{1}{2} V_s \pm 1.8$ V	100 V
Unipolar	Bipolar	55	$\frac{1}{2} V_s \pm 1.8$ V	± 100 V
Bipolar	Unipolar	13.75	± 3.6 V	100 V
Bipolar	Bipolar	27.5	± 3.6 V	± 100 V

Table 3. System gain and voltage range

Both output amplifiers are biased at approximately half the HV Bus voltage, e.g. 50 V with a 100 V range. The bias voltage can be varied by 10% using the trimmer R15.

The gain and output voltage ranges can be customized by contacting info@piezodrive.com.

Example Applications

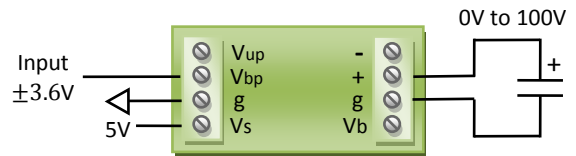

100 V Piezo stack driver with bipolar input and 50 V bias

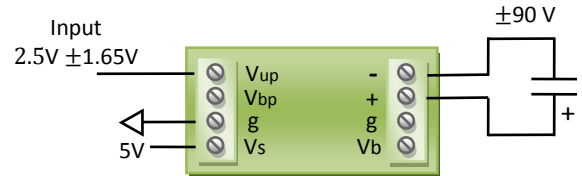

± 90 V Piezo bender driver with unipolar input

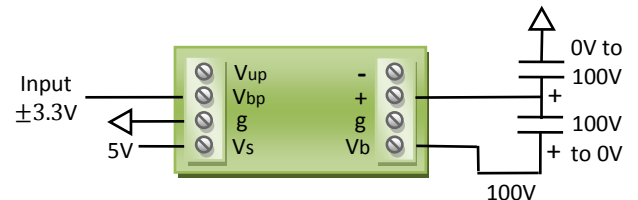

100 V Three-wire bender driver with bias

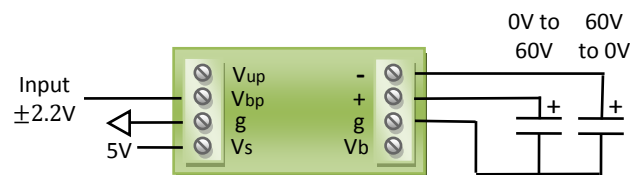

60 V Push-pull stack driver or bender driver

Output Current

The maximum output current for each voltage range is listed below.

Voltage Range	Average Output Current
60 V	±40 mA
70 V	±30 mA
90 V	±18 mA
100 V	±15 mA

Table 4. Maximum average output current

For periods less than 100 us, output currents of approximately 100 mA are possible. This is useful for achieving small, high-speed step changes in the output voltage.

Power Bandwidth

The output slew-rate of the PDU100B is 1 V/us. Therefore, the maximum frequency sine-wave is

$$f_{max} = \frac{1 \times 10^6}{\pi V_{L(p-p)}}$$

The power bandwidth for each voltage range is listed below

Voltage Range	Power Bandwidth
60 V	5.3 kHz
70 V	4.5 kHz
90 V	3.5 kHz
100 V	3.2 kHz

Table 5. Unloaded power bandwidth

With a capacitive load, the power bandwidth is limited by the maximum output current. For a sine wave

$$f_{pwr} = \frac{I_{av}}{V_{L(p-p)} \pi C_L}$$

The power bandwidth for a unipolar load is listed below. For a bipolar load, the power bandwidth is halved since the voltage range is doubled.

Load (uF)	60 V	70 V	90 V	100 V
0.01	5300	4500	3500	3200
0.03	5300	4500	2100	1500
0.1	2100	1300	630	470
0.3	700	450	210	150
1	210	130	63	47
3	70	45	21	15
10	21	13	6.4	4.8
30	7.1	4.5	2.1	1.6

Table 6. Power bandwidth versus voltage range

In the following figures, the maximum peak-to-peak voltage is plotted against frequency for a range of capacitive loads.

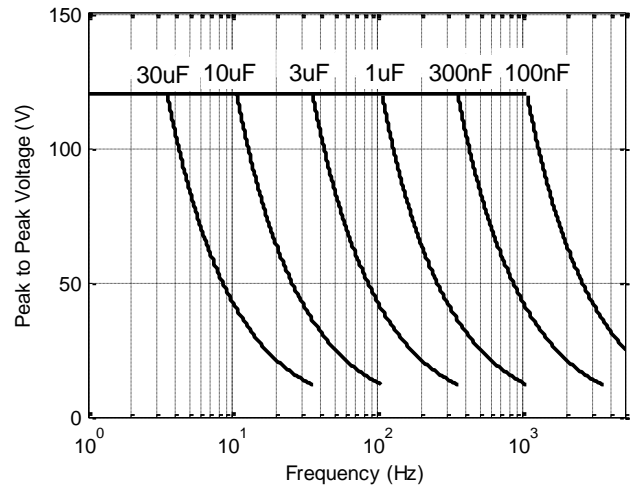

Figure 3. 60 V range power bandwidth

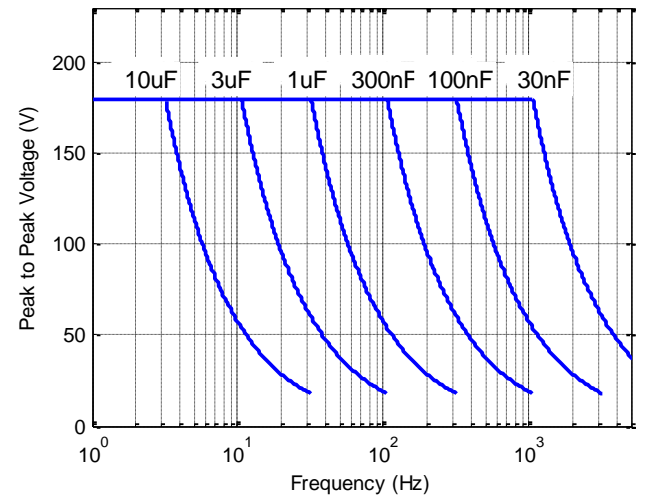

Figure 4. 90 V range power bandwidth

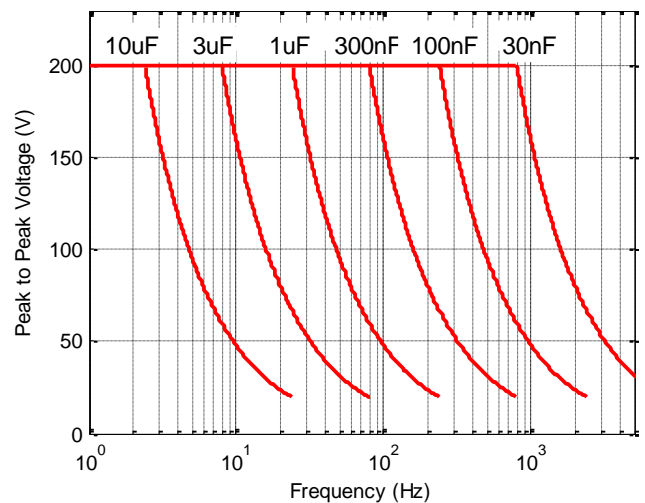

Figure 5. 100 V range power bandwidth

Signal Bandwidth

The unloaded small signal bandwidth of the PDU100B is approximately 60 kHz. With a capacitive load, the signal bandwidth is predetermined to be ten times greater than the power bandwidth, that is

$$f_{bw} = \frac{1}{1700 C_L}$$

The small signal bandwidth for a range of load capacitances is plotted in Figure 6 and listed in Table 7.

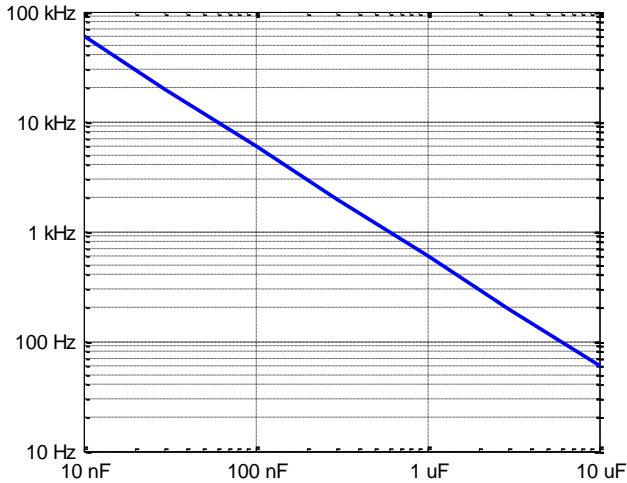

Figure 6. Signal bandwidth (f_{bw}) versus capacitance

Noise

The output voltage of the PDU100B contains switching noise from the boost converter and random noise from the high-voltage amplifier. With a 5 V supply and 100 V output range, the measured noise (Fluke 189) is listed in Table 7 below.

Load Capacitance	Signal Bandwidth	Noise (RMS)
10 nF	30 kHz	550 mV
30 nF	19 kHz	450 mV
100 nF	5.9 kHz	350 mV
300 nF	1.9 kHz	280 mV
1 uF	590 Hz	190 mV
3 uF	190 Hz	120 mV
10 uF	59 Hz	70 mV
30 uF	19 Hz	50 mV

Table 7. Signal bandwidth and noise

The output voltage noise can be reduced by using an output resistance to reduce the bandwidth. The correct circuit configurations for different applications are illustrated in Figure 8.

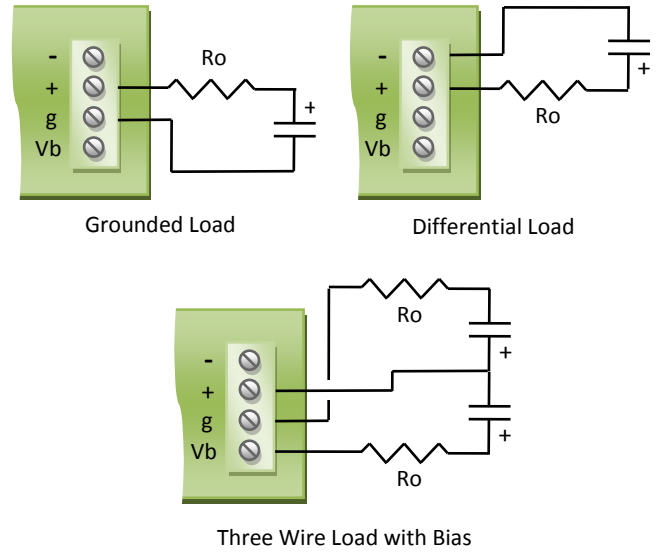

Figure 8. Noise reduction using output resistance

To determine the output resistance required for a particular noise level, the required bandwidth should be selected from Figure 9 below. The correct resistance can then be calculated from

$$R_o = \frac{1}{2\pi f_{bw} C_L} - 270$$

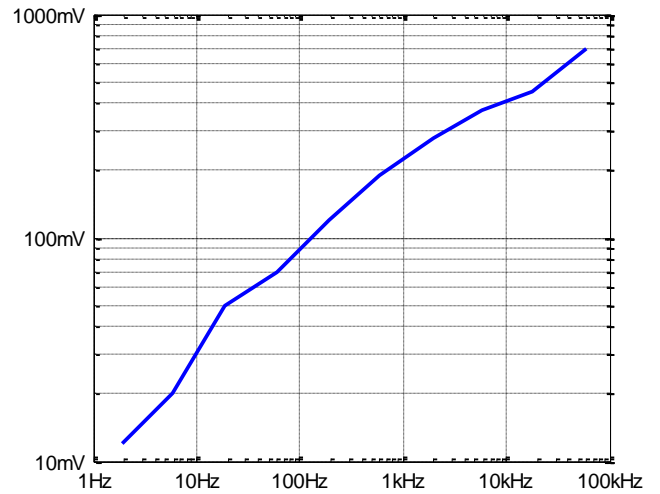

Figure 9. RMS output noise versus bandwidth

The noise measurements are performed with a static input voltage. When current is drawn from the output, the ripple will increase due to action from the boost converter.

Supply Current

The supply current (I_S) is related to the load current (I_L) through the following power balance equation:

$$I_S = I_L \frac{V_{HV} + 5}{V_S \times 0.7}$$

where V_S is the supply voltage and V_{HV} is the chosen output range (e.g. 100 V). With a capacitive load and sinusoidal voltage, the peak and average output current is

$$I_{L(pk)} = \pi f C_L V_{L(p-p)}$$

$$I_{L(av)} = 2 f C_L V_{L(p-p)}$$

where, V_L is the peak to peak voltage across the load capacitance. The average supply current can be written

$$I_{S(av)} = 2 f C_L V_{L(p-p)} \frac{V_{HV} + 5}{V_S \times 0.7}$$

Power Dissipation

With a capacitive load, power dissipation is the product of supply voltage and average current, that is

$$P_D = V_S \times I_{S(av)}$$

When operating at full power bandwidth, the worst-case power dissipation is approximately 2.5 W. The thermal impedance of the PDU100B from junction to ambient is 30 °C/W. Therefore, the maximum temperature rise is approximately 75 °C above ambient.

If full-power operation is required at ambient temperatures exceeding 50 °C, a 21 mm heat-sink is recommended on the bottom surface. This also requires the connectors to be mounted on the opposite side of the PCB. The order code for a device with unmounted connectors and heat-sink kit is PDU100B-HS.

Enable / Shutdown

The Enable pin can be pulled low to disable the amplifier and reduce the quiescent current to 1 mA. It can be driven by a logic output or an open collector output. The recovery time after a shut-down is 2 ms.

Overload Protection

The PDU100B is protected against over-current and thermal overload. If the temperature exceeds 150 °C the amplifier will be disabled until the temperature reduces.

Dimensions

The lateral dimensions are shown in Figure 10 and Figure 11. The mounting holes are designed for an M2.5 threaded spacer. The left elevation of the

standard and PCB mounting version (PDU100B-PCB) are shown in Figure 12 and Figure 13.

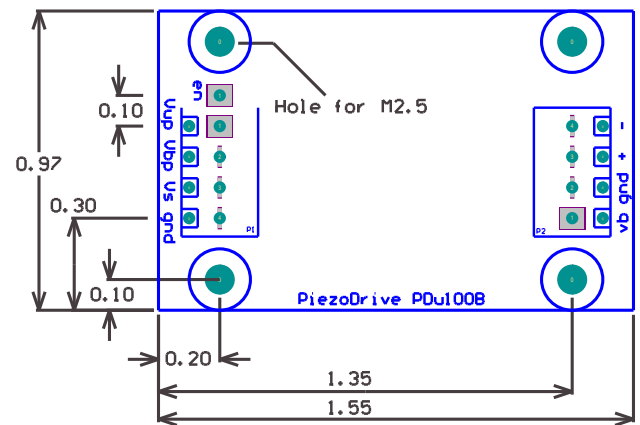

Figure 10. Top view (Inches)

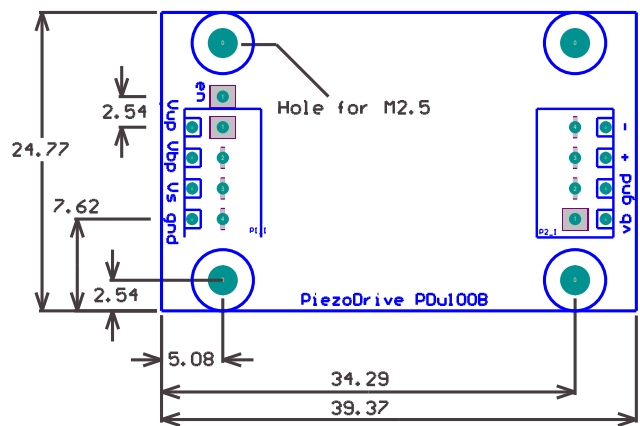

Figure 11. Top View (mm)

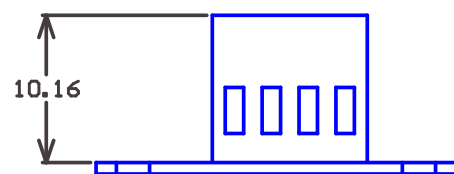

Figure 12. Left elevation: PDU100B (mm)

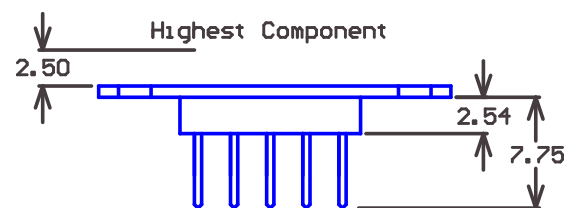

Figure 13. Left elevation: PDU100B-PCB (mm)

Contact and Support
info@piezodrive.com